

# ART 312 MK4

## PASSIVE TWO-WAY SPEAKER

### DESCRIPTION

Passive speakers for live sound reinforcement and stage monitoring as well as distributed sound systems for clubs, music venues and corporate events. ART 312 MK4 is the optimum choice for live sound situations when an exceptional full range, outstanding bass reproduction and, accurate high frequency delivery are required.



### FEATURES

- 300 Watt power handling
- 300 W AES power handling
- Dual Speakon IN/OUT
- 12" woofer, high power 2.5" voice coil
- 1" HF driver, mylar dome, 1.5" voice coil
- 680x405x345 mm 26.77x15.94x13.58 in (HxWxD)
- Finely tuned crossover
- high power handling low impedance crossover design

## TECHNICAL SPECIFICATIONS

<b>Acoustical specifications</b>	Frequency Response (-10dB):	50 Hz ÷ 20000 Hz
	Max SPL @ 1m:	127 dB
	Horizontal coverage angle:	90°
	Vertical coverage angle:	60°
<b>Power section</b>	Nominal Impedance (ohm):	8 ohm
	Power Handling:	300 W RMS
	Peak Power Handling:	1200 W PEAK
	Recommended Amplifier:	600 W
	Protections:	Electronics
	Crossover Frequencies:	1800 Hz
<b>Transducers</b>	Compression Driver:	1 x 1.0", 1.5" v.c
	Nominal Impedance (ohm):	8 ohm
	Input Power Rating:	25 W AES, 50 W PEAK
	Sensitivity:	109 dB, 1W @ 1m
	Woofer:	12", 2.5" v.c
	Nominal Impedance (ohm):	8 ohm
	Input Power Rating:	300 W AES, 600 W PEAK
Sensitivity:	98 dB, 1W @ 1m	
<b>Input/Output section</b>	Input connectors:	Speakon
	Output connectors:	Speakon
<b>Standard compliance</b>	CE marking:	Yes
<b>Physical specifications</b>	Cabinet/Case Material:	PP Composite
	Hardware:	4 x M10 Flying p.
	Handles:	2 side, 1 Top
	Pole mount/Cap:	Yes
	Color:	Black
<b>Size</b>	Height:	680 mm / 26.77 inches
	Width:	405 mm / 15.94 inches
	Depth:	345 mm / 13.58 inches
	Weight:	16 kg / 35.27 lbs
<b>Shipping informations</b>	Package Height:	740 mm / 29.13 inches
	Package Width:	461 mm / 18.15 inches
	Package Depth:	401 mm / 15.79 inches
	Package Weight:	18.6 kg / 41.01 lbs



**PART NUMBER**

- **13000586**

ART 312 MK4

EAN 8024530016982

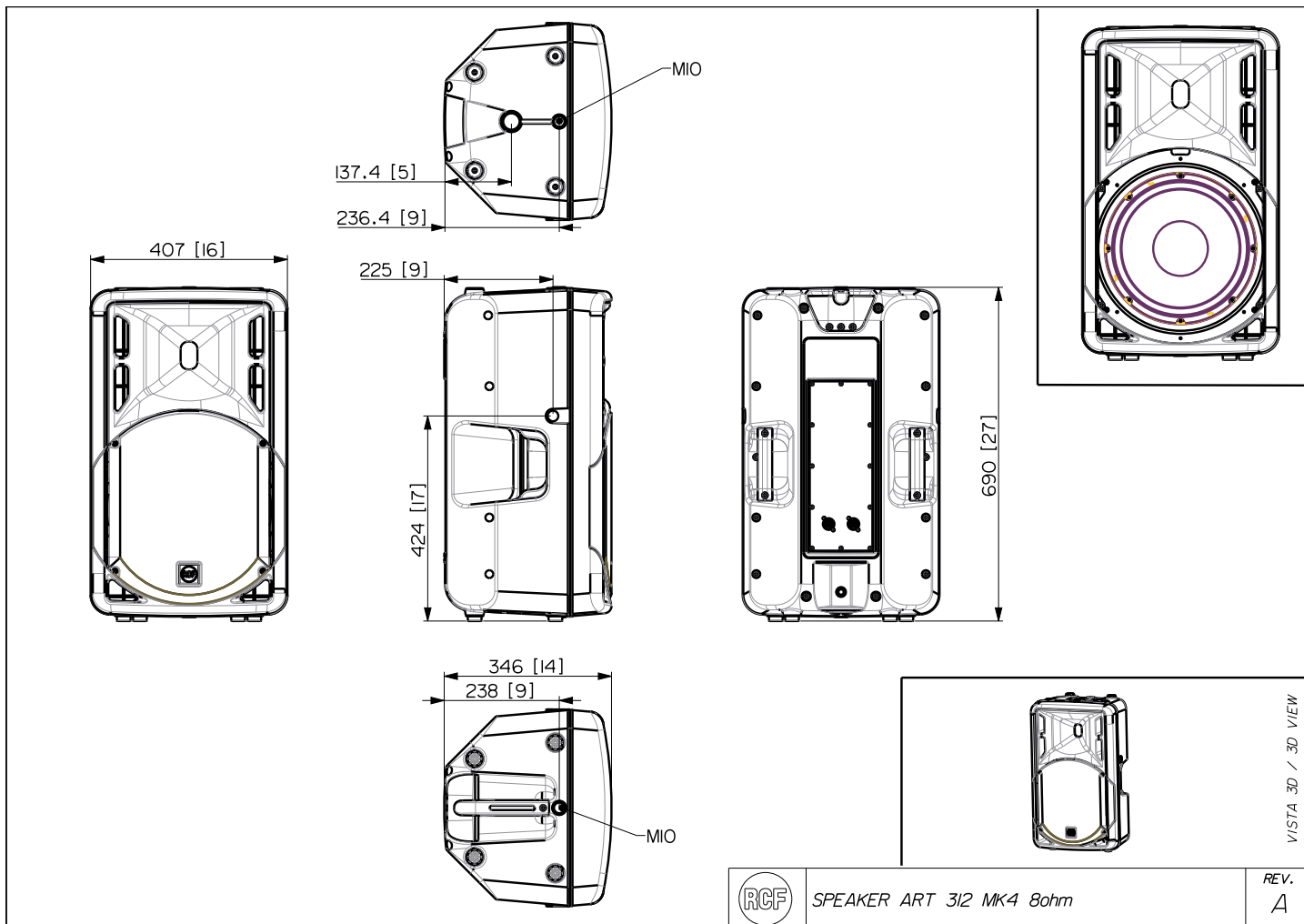

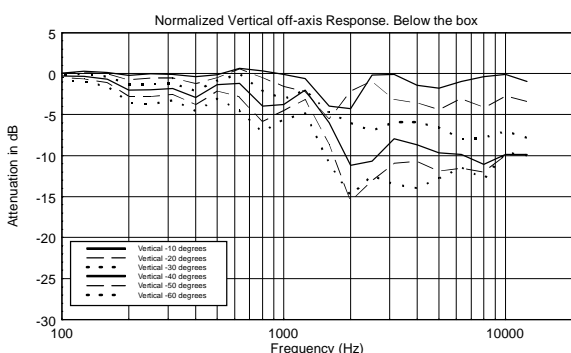
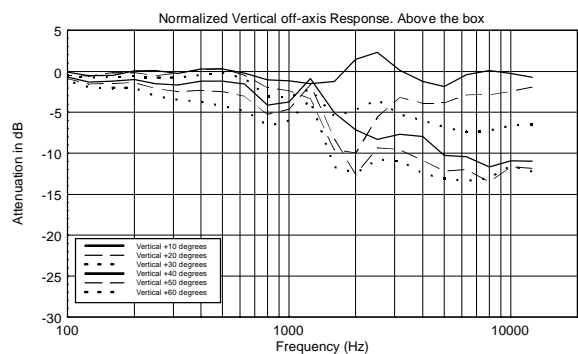
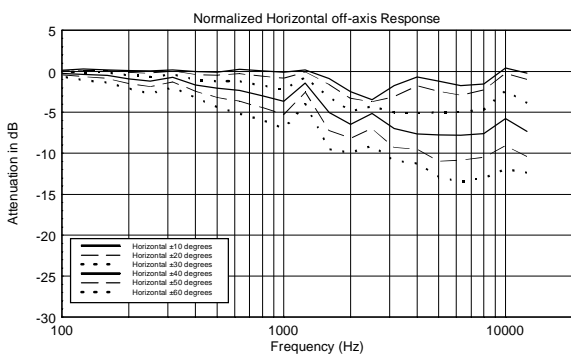
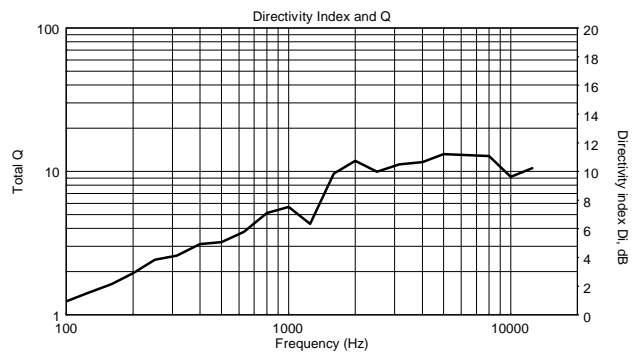
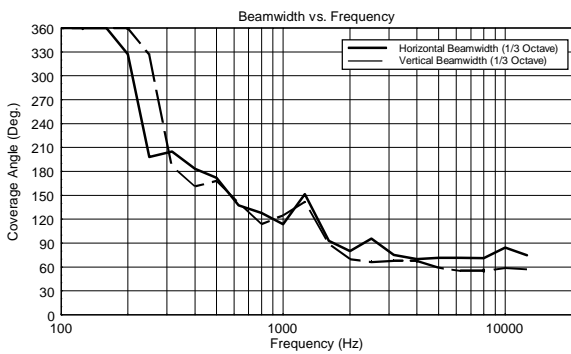
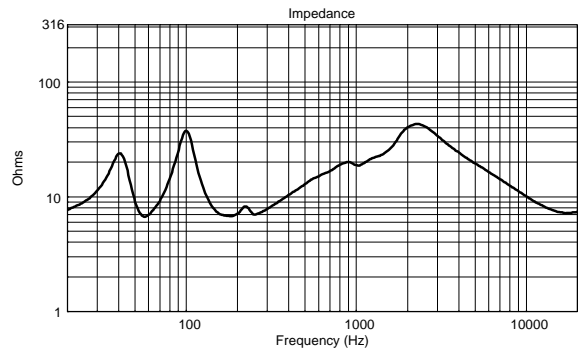
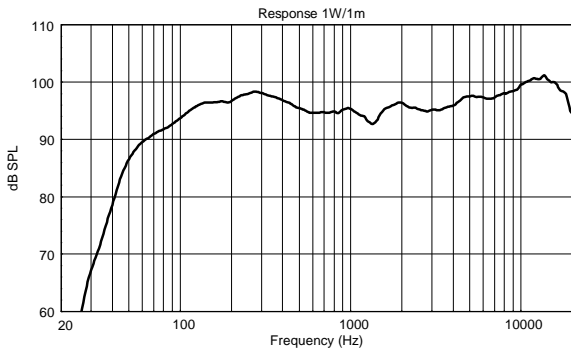

Horizontal 1/3 Octave Polars

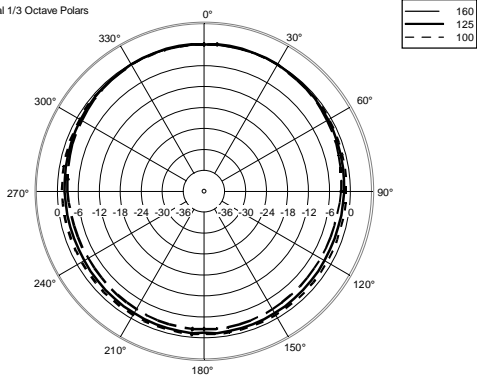

Horizontal 1/3 Octave Polars

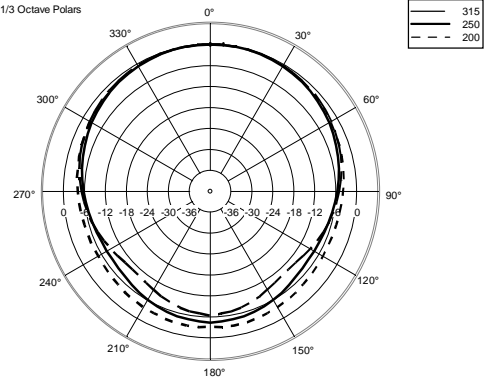

Horizontal 1/3 Octave Polars

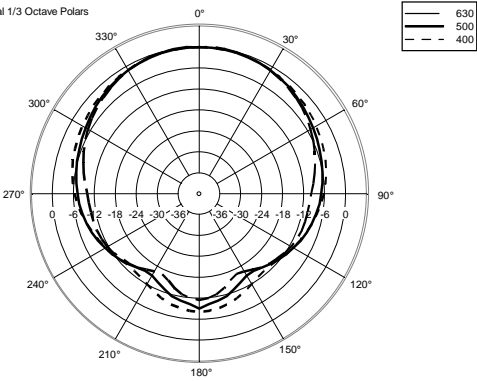

Horizontal 1/3 Octave Polars

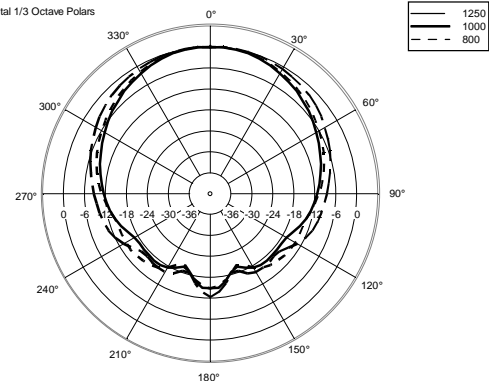

Horizontal 1/3 Octave Polars

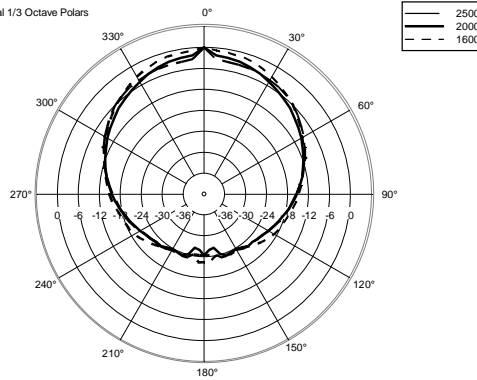

Horizontal 1/3 Octave Polars

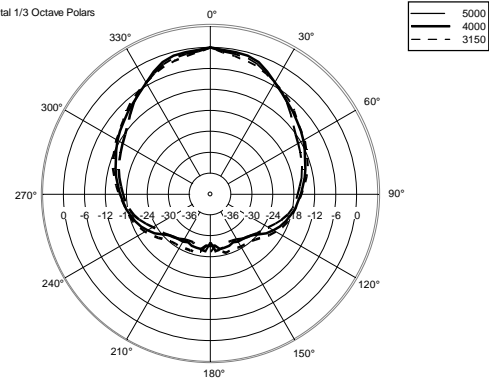

Horizontal 1/3 Octave Polars

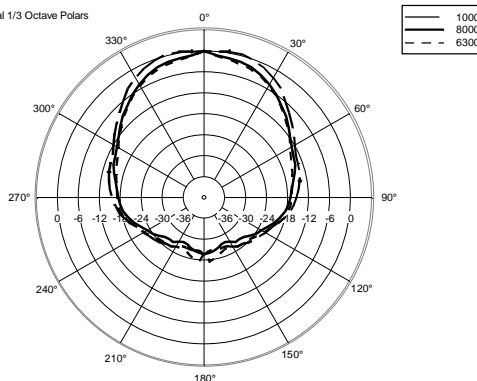

Horizontal One Octave Polars

